

ASSP

2-Channel 8-BIT D/A Converter

MB40968/40968V

■ DESCRIPTION

The Fujitsu MB40968/40968V is a 2-channel 8-bit high speed digital to analog converter for video frequency band fabricated by Fujitsu Advanced Bipolar Technology. This is suitable for YC signal processing of digital VCR.

■ FEATURES

- Resolution: 8-bits
- Linearity error: $\pm 0.2\%$ (max.)
- Maximum conversion rate: 30 MHz (Min.)
- Analog output voltage range: 3 to 5V
- Reference voltage output:
MB40968: Resistance-type potential divider output ($3/5 \times V_{CCA}$)
MB40968V: Band gap reference output ($V_{CCA} - 2$ [V])
- Digital input voltage: TTL level
- Single power supply voltage: +5.0 [V]
- Power dissipation: 270 [mW] (typ)

■ PACKAGE

Plastic DIP, 28 pin

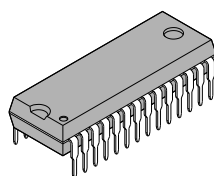

(DIP-28P-M03)

Plastic FTP, 28 pin

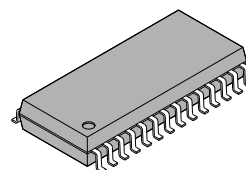

(FTP-28P-M01)

MB40968/40968V

■ PIN ASSIGNMENT

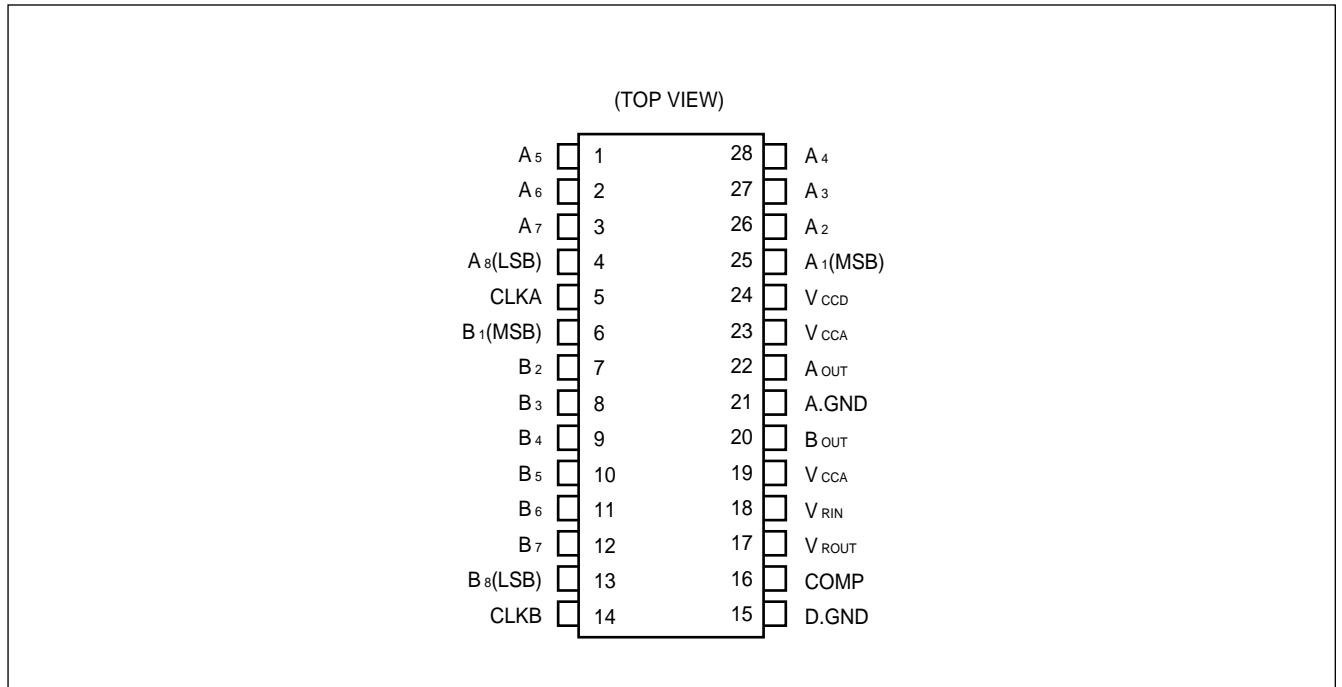

■ PIN DESCRIPTION

Pin Number	Symbol	I/O	Descriptions
25 to 28 1 to 4	A ₁ TO A ₈	I	A-channel Digital Signal Inputs: A ₁ (MSB), A ₈ (LSB)
6 to 13	B ₁ to B ₈	I	B- channel Digital Signal Inputs: B ₁ (MSB), B ₈ (LSB)
5	CLK _A	I	A-channel Clock Input
14	CLK _B	I	B-channel Clock Input
24	V _{CCD}	—	Power Supply for Digital Circuit
19, 23	V _{CCA}	—	Power Supply for Analog Circuit, two pins (19,23) should be used.
15	D-GND	—	Ground for Digital Circuit
21	A-GND	—	Ground for Analog Circuit
18	V _{RIN}	I	Terminal for reference voltage input. Zero scale voltage of analog output is specified applying any voltage to this terminal. Input reference voltage should be 2.7 to 4.3V and, $V_{CCA} - V_{RIN} \leq 2.2V$
17	MB40968 V _{ROUT}	O	Terminal for reference voltage output by resistance-type potential divider. Analog output of " V_{CCA} to $3/5 \times V_{CCA}$ " is supplied connecting this terminal with V _{RIN} terminal.
	MB40968 V _{ROUT}	O	Terminal for reference voltage output consists of Band Gap reference. This terminal supplies the voltage of " $V_{CCA} - V_{CCA} - 2V$ ". 2V output is maintained connecting this terminal with V _{RIN} , even if the power supply fluctuates frequently.
16	COMP	—	Terminal for phase compensation capacitance; Capacitance of 1 μ F or more should be inserted between COMP and A-GND.
22	A _{OUT}	O	A-channel Analog Signal Output
20	B _{OUT}	O	B-channel Analog Signal Output

MB40968/40968V

■ BLOCK DIAGRAM

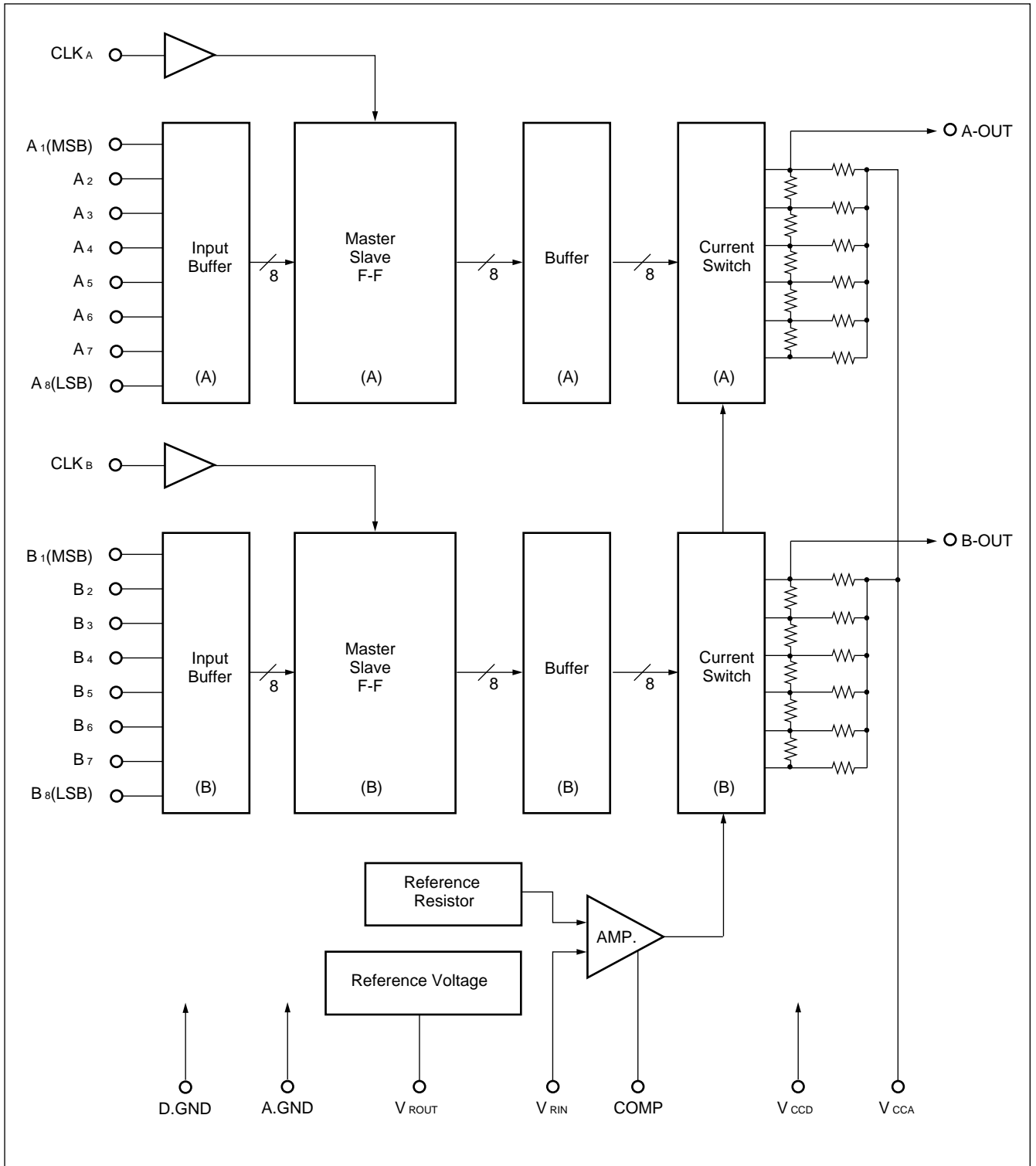

■ ABSOLUTE MAXIMUM RATINGS

Rating	Symbol	Value	Unit
Power supply voltage	V_{CCA}, V_{CCD}	-0.5 to +7.0	V
Supply voltage difference	$V_{CCD} - V_{CCA}$	1.5	V
Digital input voltage	V_{ID}	-0.5 to +7.0	V
Storage temperature	T_{STG}	-55 to +125	°C

Precautions: Permanent device damage may occur if the above Absolute Maximum Ratings are exceeded. Functional operation should be restricted to the conditions as detailed in the operational sections of this data sheet. Exposure to absolute maximum rating conditions for extended periods may affect device reliability.

■ RECOMMENDED OPERATING CONDITIONS

Parameter	Symbol	Value			Unit
		Min.	Typ.	Max.	
Power supply voltage	V_{CCA}, V_{CCD} ($V_{CCA} - V_{CCD}$)	4.75 (-0.2)	5.00	5.25 (0.2)	V
Analog reference voltage	$V_{CCA} - V_{RIN}$	0.70	2.00	2.20	V
	V_{RIN}	2.70	3.00	4.30	
High level digital Input voltage	V_{IHD}	2.0	—	—	V
Low level digital input voltage	V_{ILD}	—	—	0.8	V
Clock frequency	f_{CLK}	—	—	30	MHz
Data set up time	t_{SU}	10.0	—	—	ns
Data hold time	t_h	4.0	—	—	ns
High level clock pulse width	t_{WH}	10.0	—	—	ns
Low level clock pulse width	t_{WL}	10.0	—	—	ns
Phase compensation capacitance	C_{COMP}	1.0	—	—	μF
Operating temperature	T_{op}	0	—	70	°C

MB40968/40968V

■ ELECTRICAL CHARACTERISTICS

($V_{CC} = 4.75$ to $5.25V$, $T_a = 0$ to $70^{\circ}C$)

Parameter	Symbol	Condition	Value			Unit
			Min.	Typ.	Max.	
Resolution	—	—	—	—	8	Bit
Linearity error	LE	DC	—	—	± 0.2	%
Reference input current	I_{RIN}	$V_{RIN} = 3.000 (V)$	—	—	10	μA
High level digital input current	I_{IND}	$V_{IND} = 2.7 (V)$	—	—	20	μA
Low level digital input current	I_{ILD}	$V_{ILD} = 0.4 (V)$	-100	—	—	μA
2-channel's output voltage ratio	FSR	$V_{CCA} = 5.00 (V)$ $V_{CCD} = 5.00 (V)$ $V_{RIN} = V_{ROUT}$	0	—	4	%
Full-scale analog output voltage	V_{OFS}	$V_{CCA} = 5.00 (V)$ $V_{CCD} = 5.00 (V)$ $V_{RIN} = V_{ROUT}$	V_{CCA} -0.015	V_{CCA}	—	V
Zero-scale analog output voltage	V_{OZS}	$V_{CCA} = 5.00 (V)$ $V_{CCD} = 5.00 (V)$ $V_{RIN} = 3.000 (V)$	2.938	3.008	3.078	V
Output resistance	R_O	$T_a = 25^{\circ}C$	192	240	288	Ω
Power supply current	I_{CC}	$V_{CCA} = 5.00 (V)$ $V_{CCD} = 5.00 (V)$ $V_{RIN} = V_{ROUT}$	—	54*	80	mA

* : $V_{CC} = 5.00 (V)$

MB40968

Reference output voltage	V_{ROUT}	$V_{CCA} = 5.00 (V)$ $V_{CCD} = 5.00 (V)$	2.900	3.000	3.100	V
--------------------------	------------	--	-------	-------	-------	---

MB40968V

Reference output voltage	V_{ROUT}	—	V_{CCA} -2.100	V_{CCA} -2.000	V_{CCA} -1.900	V
Reference output voltage temperature constant	—	—	—	100	—	ppm/ $^{\circ}C$

Switching Characteristics

($V_{CC} = 4.75$ to $5.25V$, $T_a = 0$ to $70^{\circ}C$)

Parameter	Symbol	Condition	Value			Unit
			Min.	Typ.	Max.	
Minimum conversion rate	F_s	—	30	—	—	MSPS
Output delay time	t_{PLH} t_{PHL}	$C_L = 15 pF$	—	10	—	ns
Output rise time	t_r	Terminated A.OUT pin with 240Ω	—	5	—	ns
Output fall time	t_f		—	5	—	ns
Settling time	t_{setLH} t_{setHL}	Terminated B.OUT pin with 240Ω	—	15	—	ns

MB40968/40968V

Figure 3 Digital Input Equivalent Circuit (A₁ to A₈, B₁ to B₈, CLK_A, CLK_B)

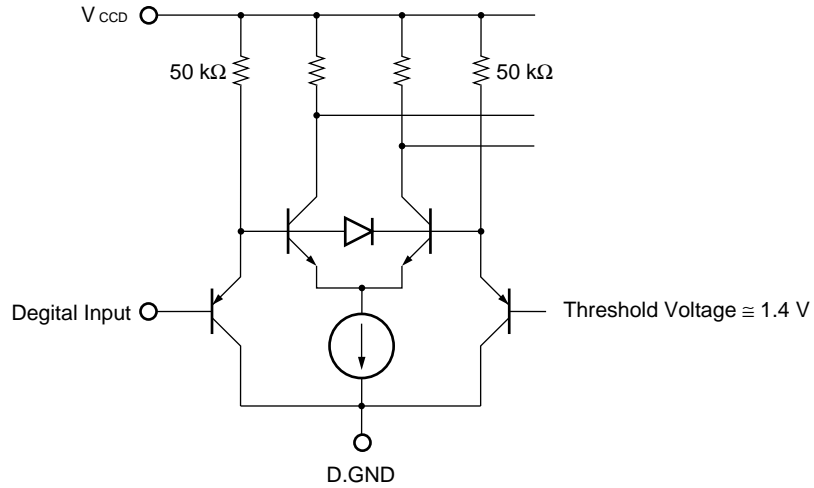

Figure 4 Analog Output Equivalent Circuit (A_{OUT}, B_{OUT})

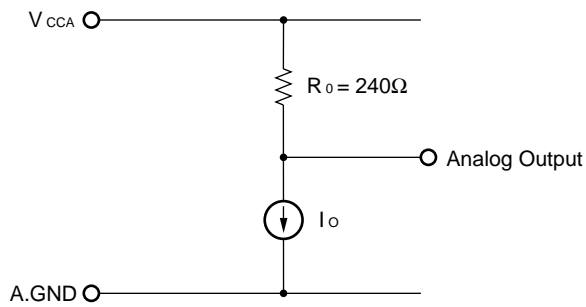

Figure 5 MB40968 Reference Output Voltage (V_{ROUT})

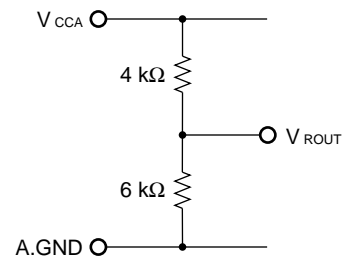
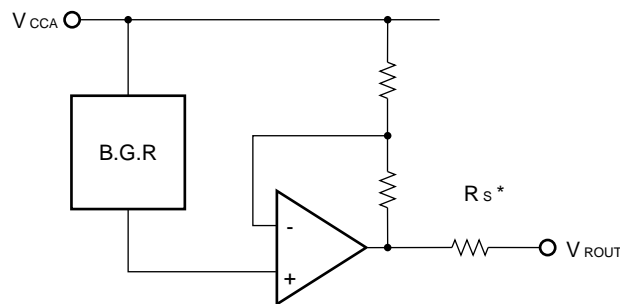

Figure 6 MB40968V Reference Output Voltage (V_{ROUT})



Note*: Reference for preventing over current when short circuit with GND.

The relations between Digital input code and Analog output voltage of MB40968/40968V are ideally indicated as follows.

$$AOUT_N(BOUT_N) = V_{CCA} - \frac{255 - N}{256} \times (V_{CCA} - V_{RIN}) \quad N: 0 \text{ to } 255 \text{ Digital Input Code}$$

$$VOFS = V_{CCA}$$

$$VOZS = V_{CCA} - \frac{255}{256} \times (V_{CCA} - V_{RIN})$$

Output Voltage Ratio between 2 channels is calculated as follows.

$$FSR = \left[\frac{VOFS(A) - VOZS(A)}{VOFS(B) - VOZS(B)} - 1 \right] \times 100\%$$

MB40968/40968V

■ TYPICAL CONNECTION EXAMPLE

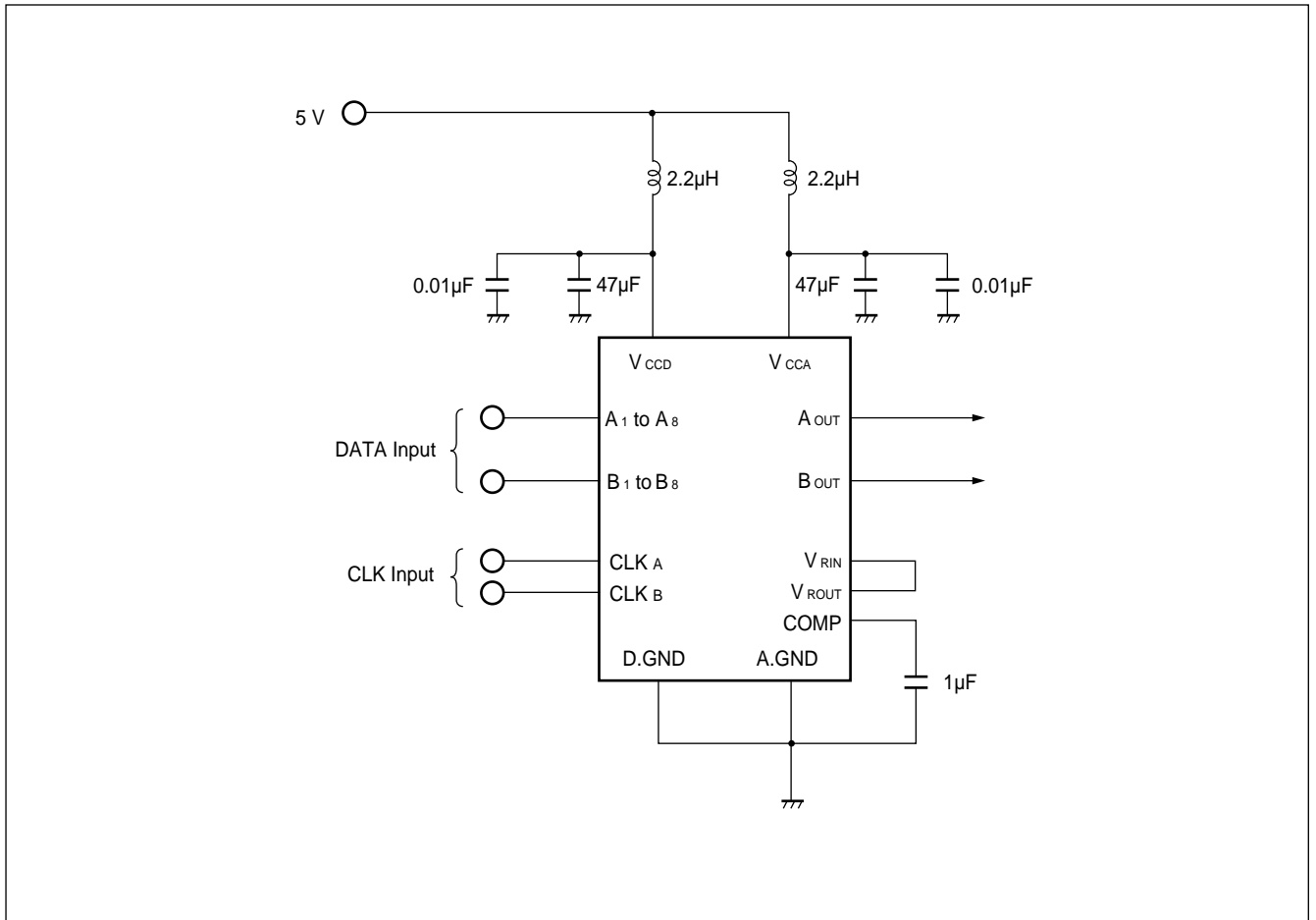

■ PRECAUTIONS

1. Inter-channel Crosstalk

The MB88361 is a 2-channel D/A converter, requiring the use of special mounting methods to minimize crosstalk between analog output pins.

Specifically, it is recommended that PC board designs should emphasize the prevention of large coupling capacities between analog output lines. (See ■TYPICAL CHARACTERISTIC CURVES.)

2. Prevention of Switching Noise

To reduce superimposed switching noise on the analog output signal to an absolute minimum, it is recommended that a noise limiting capacitor between the V_{CCA} and V_{CCD} pins be placed as close as possible to the pins and connected to the A.GND and D.GND pins.

3. Power Supply Patterns

Power supply patterns connected to the A.GND and B.GND pins should be as possible in order to reduce parasitic impedance.

MB40968/40968V

TYPICAL CHARACTERISTIC CURVES

Figure 7 Power Supply Current vs. Operating Temperature

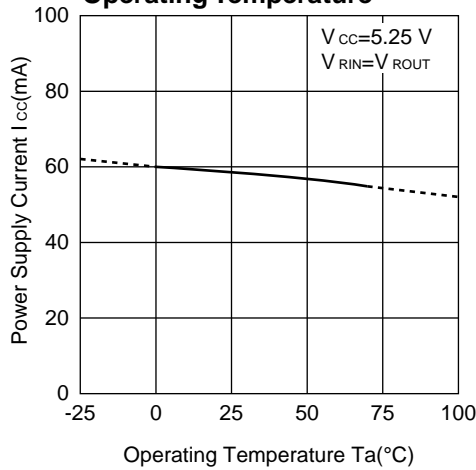

Figure 8 Linearity Error vs. Operating Temperature

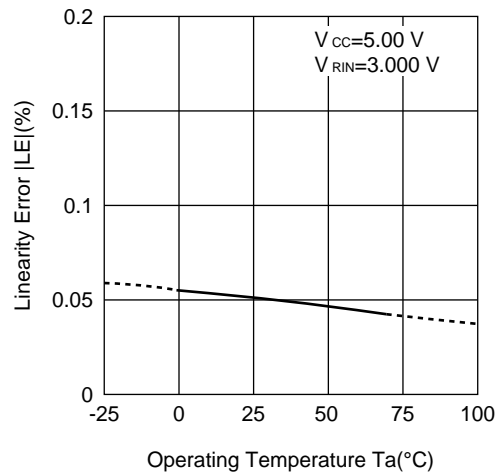

Figure 9 Output Resistance vs. Operating Temperature

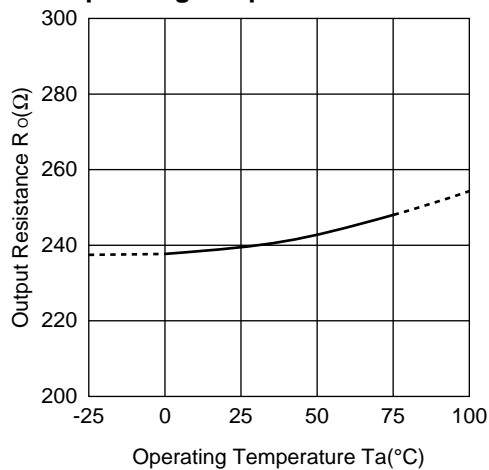

Figure 10 Full-Scale Analog Output Voltage vs. Operating Temperature

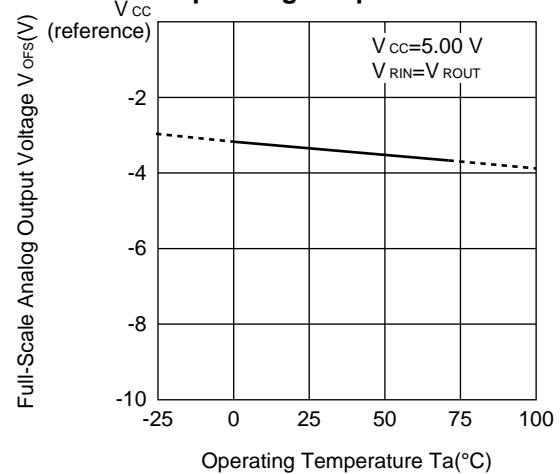

Figure 11 Zero-Scale Analog Output Voltage vs. Operating Temperature

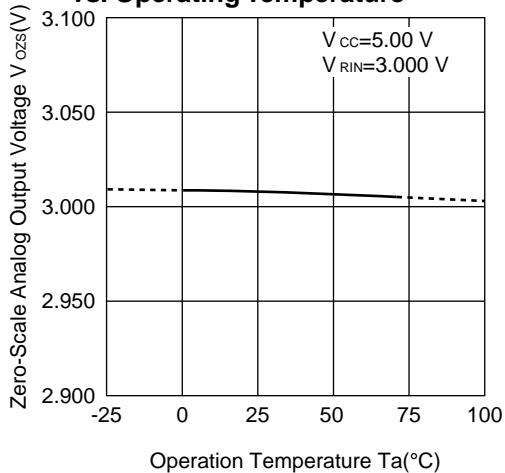
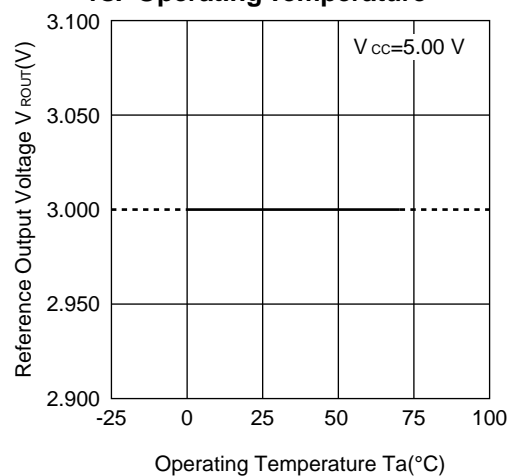

Figure 12 MB40968 Reference Output Voltage vs. Operating Temperature



(Continued)

Figure 13 MB40968V Reference Output Voltage vs. Operating Temperature

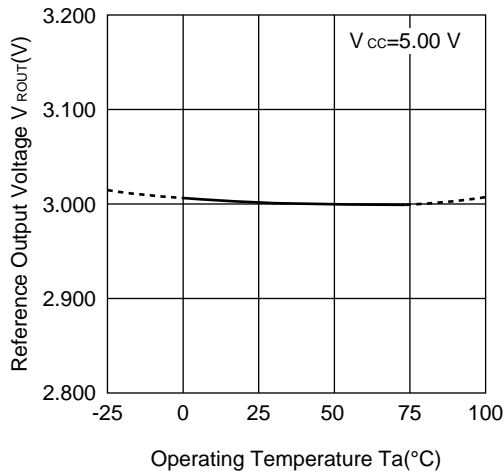

Figure 14 MB40968V Analog Reference Voltage vs. Power Supply Voltage

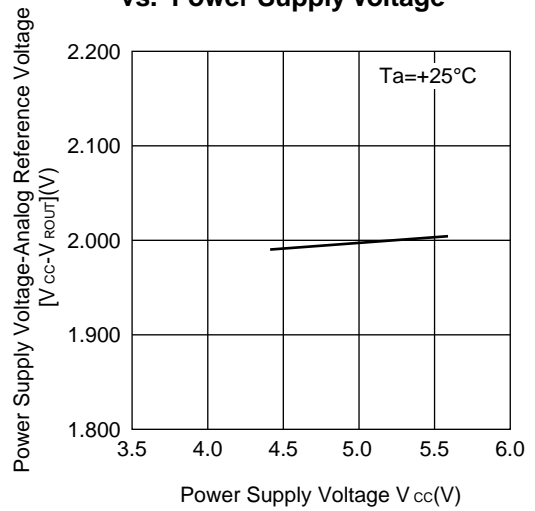

Figure 15 Data Set Up Time vs. Operating Temperature

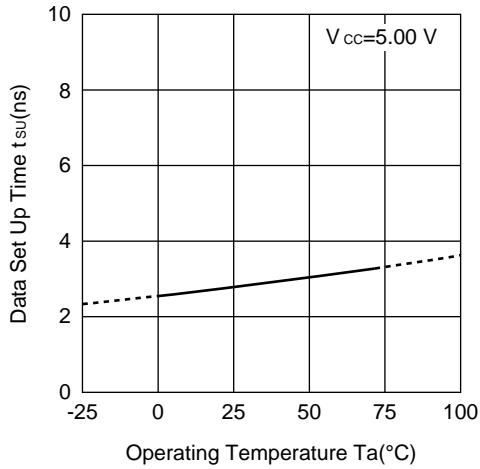

Figure 16 Data Set Up Time vs. Power Supply Voltage

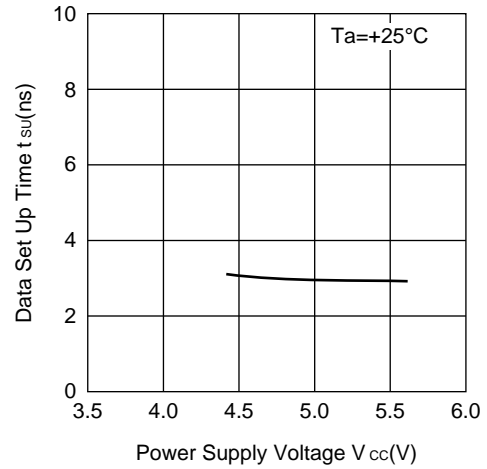

Figure 17 Data Hold Time vs. Operating Temperature

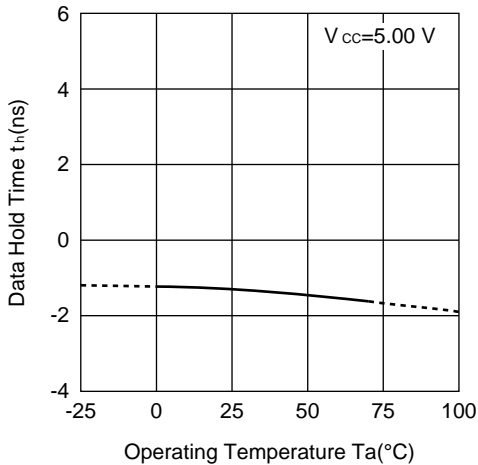
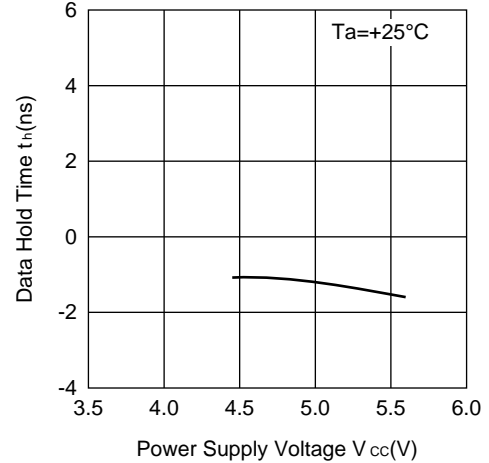

Figure 18 Data Hold Time vs. Power Supply Voltage



(Continued)

MB40968/40968V

(Continued)

Figure 19 Output Rise, Fall Time vs. Operating Temperature

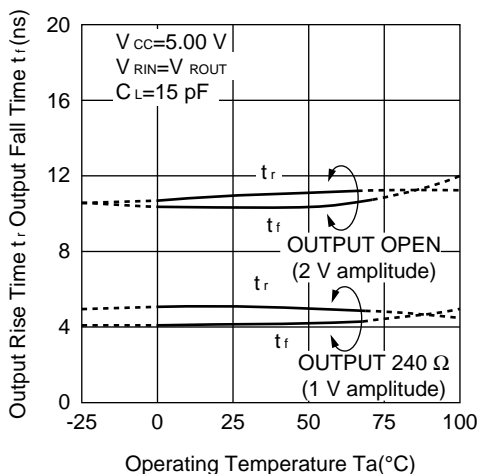

Figure 20 Output Rise, Fall Time vs. Power Supply Voltage

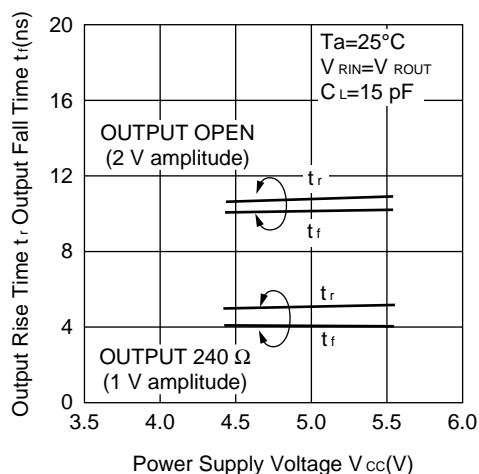

Figure 21 Output Delay Time vs. Operating Temperature

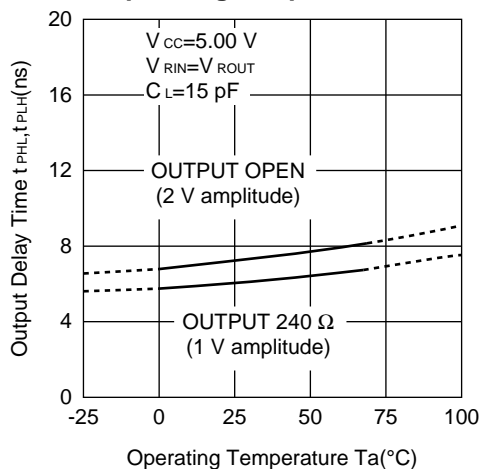

Figure 22 Output Delay Time vs. Power Supply Voltage

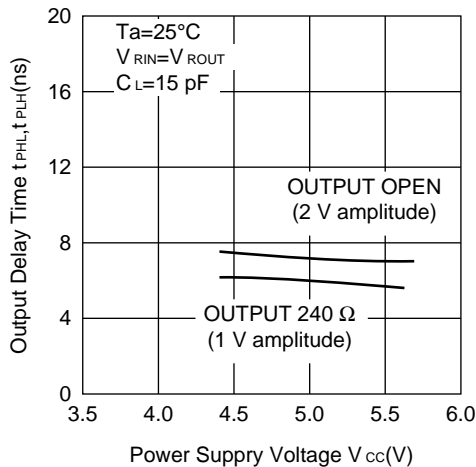

Figure 23 Clock Pulse Width vs. Operating Temperature

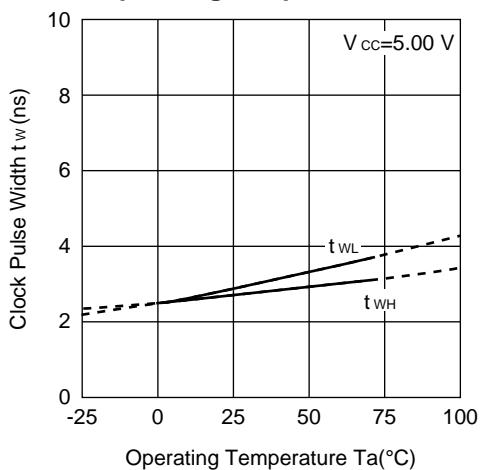
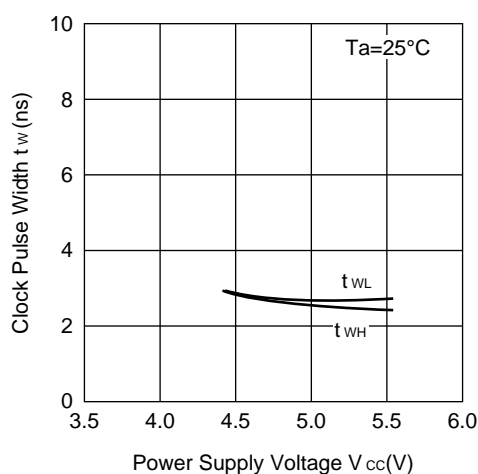

Figure 24 Clock Pulse Width vs. Power Supply Voltage



MB40968/40968V

■ PACKAGE DIMENSION

28 pin, Plastic SH-DIP
(DIP-28P-M03)

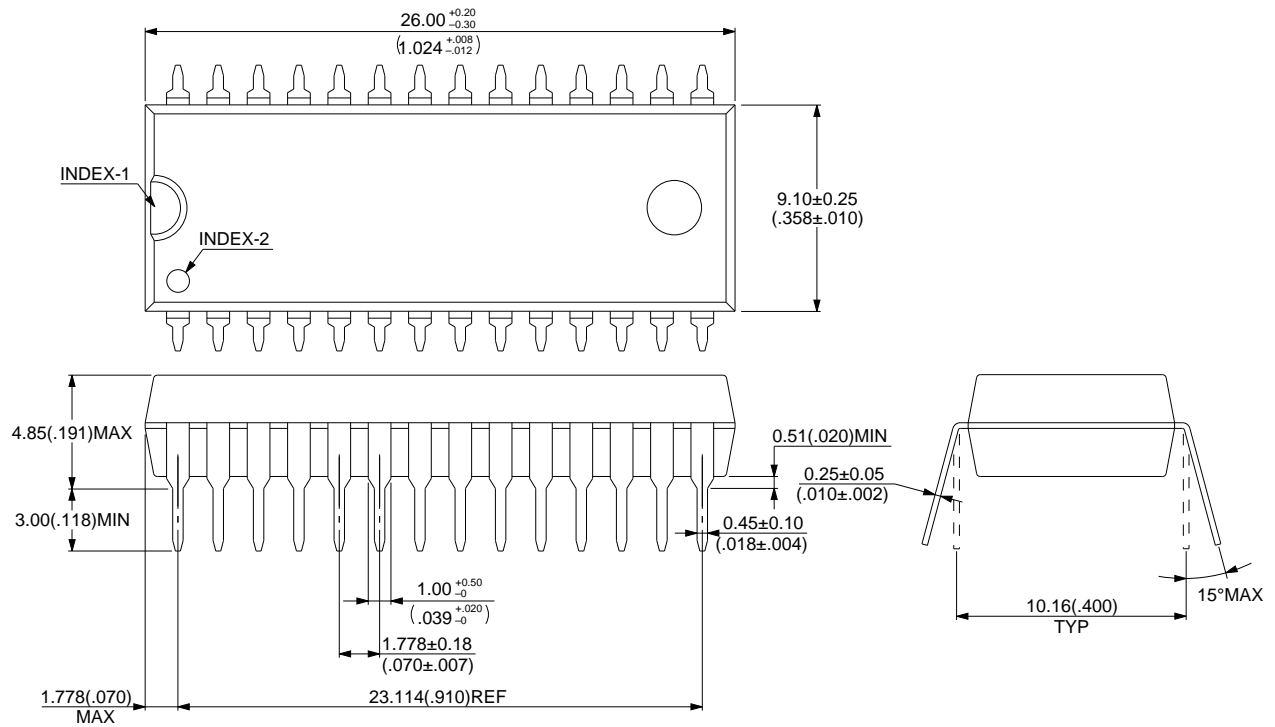

Dimensions in mm (inches).

© 1994 FUJITSU LIMITED D28012S-3C-3

(Continued)

MB40968/40968V

(Continued)

28 pin, Plastic SOP
(FTP-28P-M01)

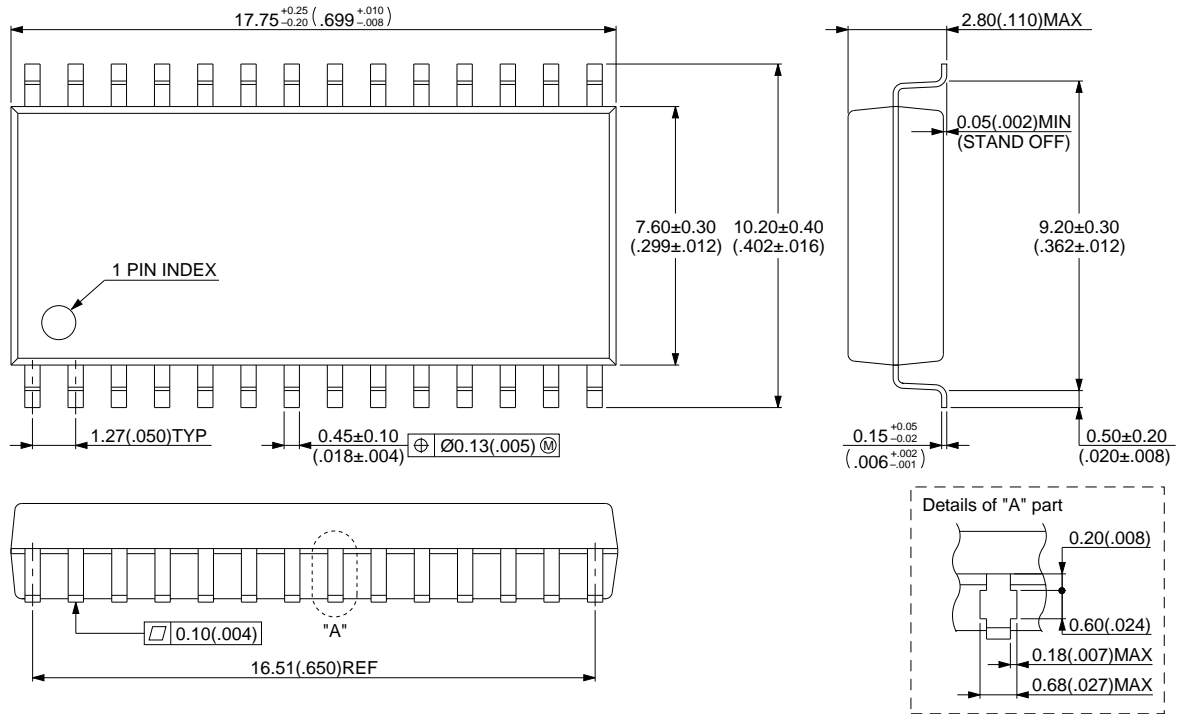

© 1994 FUJITSU LIMITED F28005S-5C-4

Dimensions in mm (inches).

FUJITSU LIMITED

For further information please contact:

Japan

FUJITSU LIMITED
Corporate Global Business Support Division
Electronic Devices
KAWASAKI PLANT, 4-1-1, Kamikodanaka
Nakahara-ku, Kawasaki-shi
Kanagawa 211-88, Japan
Tel: (044) 754-3763
Fax: (044) 754-3329

North and South America

FUJITSU MICROELECTRONICS, INC.
Semiconductor Division
3545 North First Street
San Jose, CA 95134-1804, U.S.A.
Tel: (408) 922-9000
Fax: (408) 432-9044/9045

Europe

FUJITSU MIKROELEKTRONIK GmbH
Am Siebenstein 6-10
63303 Dreieich-Buchsschlag
Germany
Tel: (06103) 690-0
Fax: (06103) 690-122

Asia Pacific

FUJITSU MICROELECTRONICS ASIA PTE. LIMITED
#05-08, 151 Lorong Chuan
New Tech Park
Singapore 556741
Tel: (65) 281-0770
Fax: (65) 281-0220

All Rights Reserved.

The contents of this document are subject to change without notice. Customers are advised to consult with FUJITSU sales representatives before ordering.

The information and circuit diagrams in this document presented as examples of semiconductor device applications, and are not intended to be incorporated in devices for actual use. Also, FUJITSU is unable to assume responsibility for infringement of any patent rights or other rights of third parties arising from the use of this information or circuit diagrams.

FUJITSU semiconductor devices are intended for use in standard applications (computers, office automation and other office equipment, industrial, communications, and measurement equipment, personal or household devices, etc.).

CAUTION:

Customers considering the use of our products in special applications where failure or abnormal operation may directly affect human lives or cause physical injury or property damage, or where extremely high levels of reliability are demanded (such as aerospace systems, atomic energy controls, sea floor repeaters, vehicle operating controls, medical devices for life support, etc.) are requested to consult with FUJITSU sales representatives before such use. The company will not be responsible for damages arising from such use without prior approval.

Any semiconductor devices have inherently a certain rate of failure. You must protect against injury, damage or loss from such failures by incorporating safety design measures into your facility and equipment such as redundancy, fire protection, and prevention of over-current levels and other abnormal operating conditions.

If any products described in this document represent goods or technologies subject to certain restrictions on export under the Foreign Exchange and Foreign Trade Control Law of Japan, the prior authorization by Japanese government should be required for export of those products from Japan.